

Phoenix PV Jaw Crusher PV

© Copyright 2019 Phoenix.

20100303

20190806

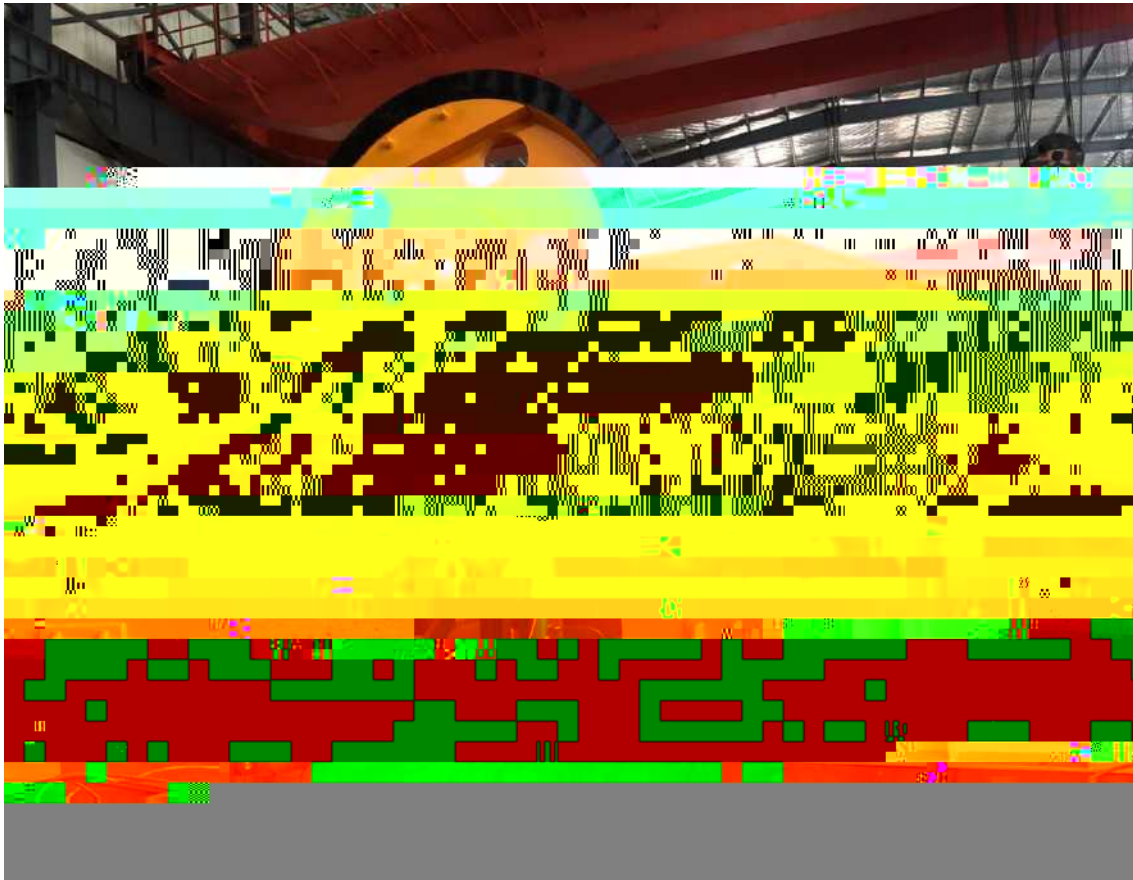

705 4 B
021-58973788 021-58975926
info@shhyj.com
www.shhyj.com

3.3	23
4.	25
4.1	26
4.1.1	26
4.1.2	26
4.1.3	26
4.2	27
4.2.1	27
4.2.2	29
4.2.3	30
4.2.4	30
5.	28
5.1	29
5.1.1	29
5.1.2	29
5.1.3	29
5.2	30
5.3	31
5.4	32
5.5	33
5.5.1	33
5.5.2	34
5.5.3	34
5.5.4	35
5.6	36
5.6.1	36
5.6.2	37
5.7	38
5.7.1	38
5.7.2 CSS	39
5.7.3	39

6.	38
6.1	39
6.1.1	39
6.1.2	39
6.1.3	39
6.2	40
6.2.1	40
6.2.2	41
7.	43
7.1	43
7.1.1	43
7.1.2	43
7.1.3	43
7.2	44
7.3	45
7.3.1	46
7.3.2	47
7.4	48
7.4.1	48
7.4.2	50
7.5	52
7.5.1	52
7.5.2	53
7.6	55
7.6.1	56
7.6.2	57
8.	59
8.1	59
8.1.1	59
8.1.2	59
8.1.3	59

8.2	60
8.3	61
8.3.1	62
9.	65
9.1	66
9.1.1	66
9.1.2	66
9.1.3	66
9.2	67

1.

2.

1.1

Phoenix

705

<http://www.shyyj.com>

:

705

021-58973788

021-58975926

info@shyyj.com

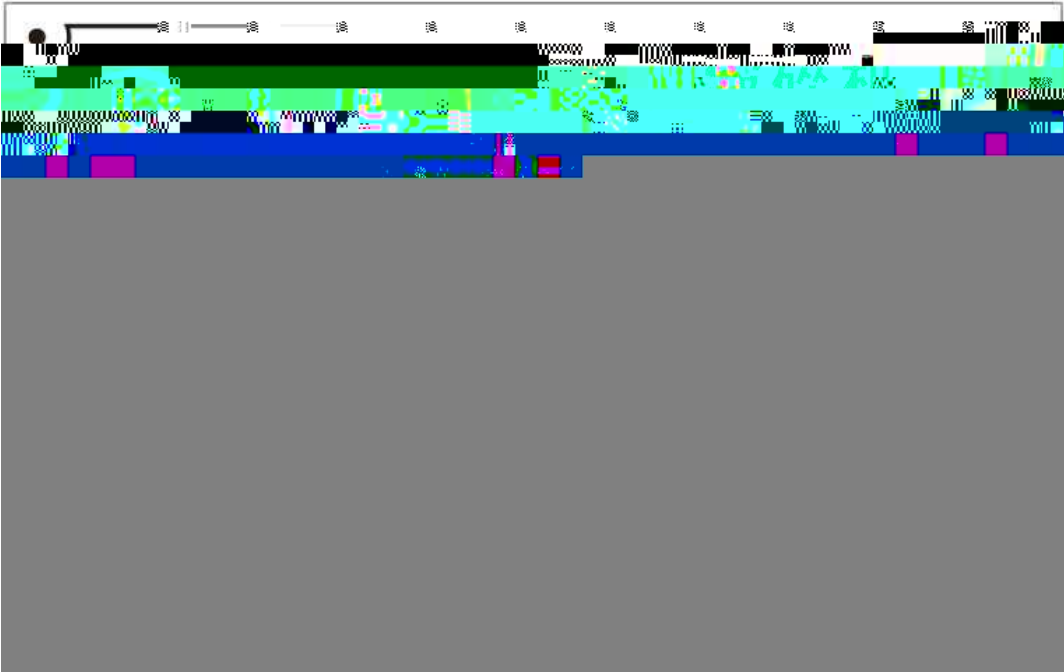

- 1
- 2
- 3
- 4
- 5
- 6
- 7
- 8

1.1.1

"
"

OM

info@shyyj.com

1.2

3

4

2

5

1

6

5.

1.2.1

- 1
- 2
- 3
- 4
- 5
- 6
- 7
- 8
- 9
- 10

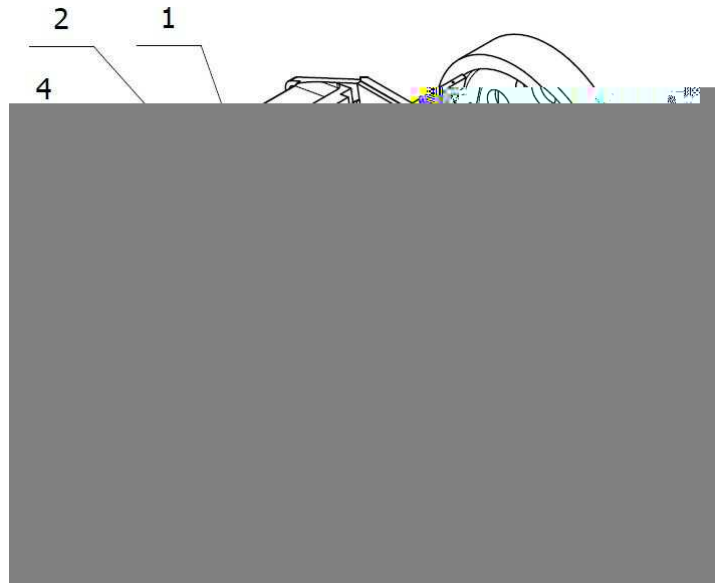

- 11
- 12
- 13
- 14
- 15
- 16
- 17



1.2.2

型号	给料口尺寸 (mm)	最大给料 (mm)	排料口宽度 (mm)	电机功率 (kw)	电机转速 (r/min)	重量 (t)
PV710	760*1060	500	75-200	110	750	17.3
PV912	900*1200	800	154-250	132	1000	39.3

2.

2.1

2.1.1

	
"	"

	
"	"



" "

2.1.2



- 1.
- 2.
- 3.
- 4.

2.1.3

















2.1.4





2.1.5



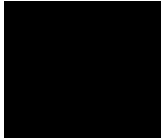

2.1.6

2.2

	
 	2.2 CE (PPE)

2.3



“ ”

2.4



“

“ ”

“

“
”
”
”
”



“ ” “ ”



“
”
”

2.5





“ ”



2.6

“ ”

	
 	“ ” - - -



“ ”



“ ”

2.7

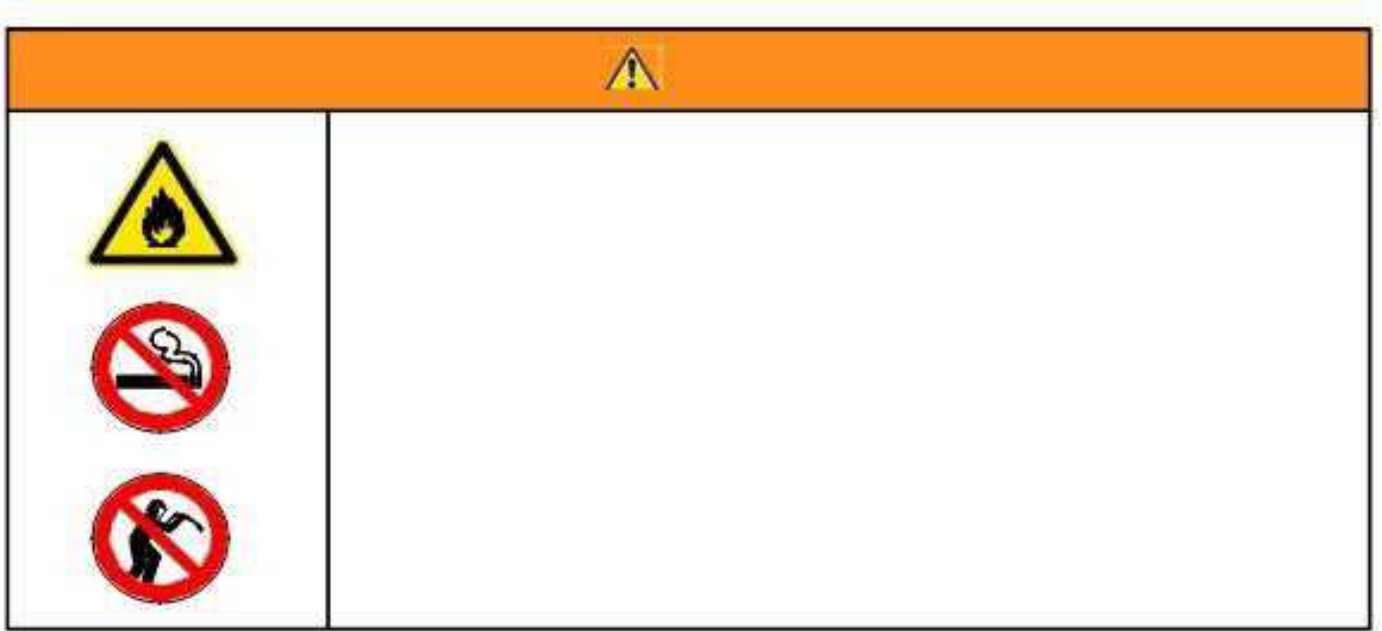

2.8



OEM



2.9

2.10

"

2.11

" "

2.11.1



OEM



2.11.2

2.12

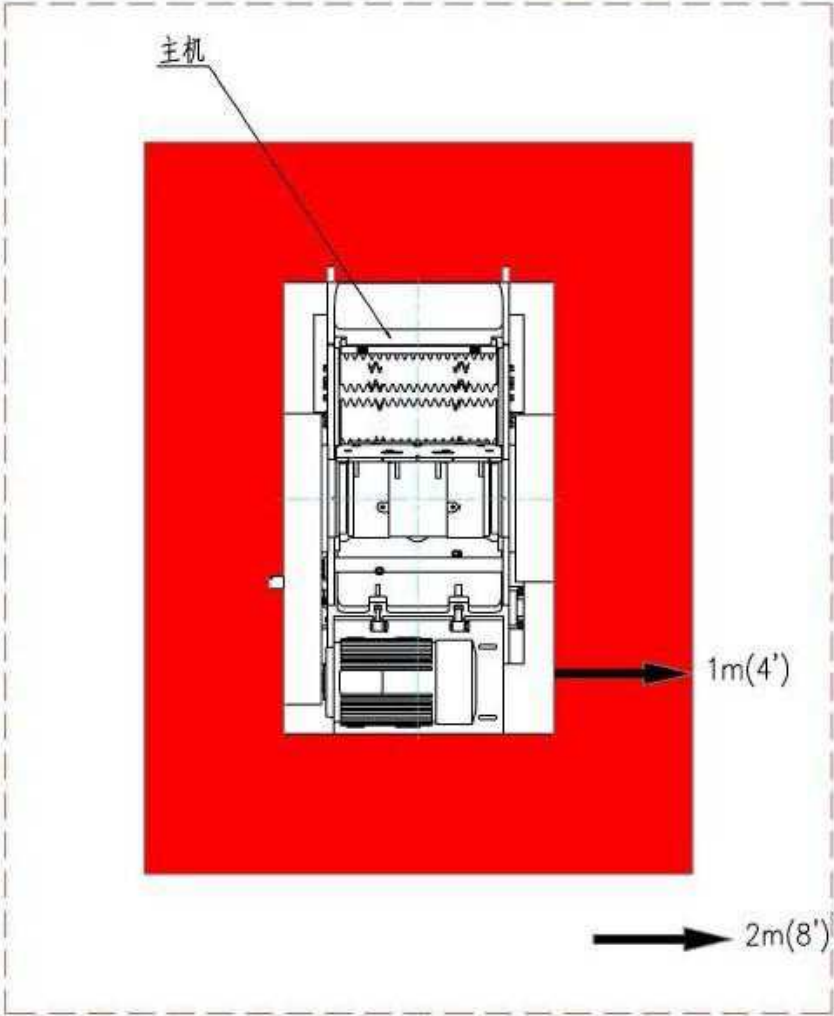

2m(8')禁区

距离

3.

2.

3.1

	PV912
()	39320 kg
	4456 mm
	2198 mm
	3411 mm
	240 rpm
	900x1200 mm
	800 mm
	160 kW
	1000 /

3.2

CSS – a	154 250 mm
	238 330 /

a.

3.3

PV912

	PV912-38	116
	PV912.2-15a	145
	PV912-37	2690
	PV912.2-14	1691
	PV912.2-17	276
	PV912-3a	248
	PV912-5	154
	PV912-4	248
	PV912-6	154

4.

2.

4.1

" "

" "

" "

4.1.1

"

"

4.1.2



"

/

"

"

" "

"

"

-

4.1.3



“ ”

“ ”

4.2

4.2.1

CSS

3.

CSS

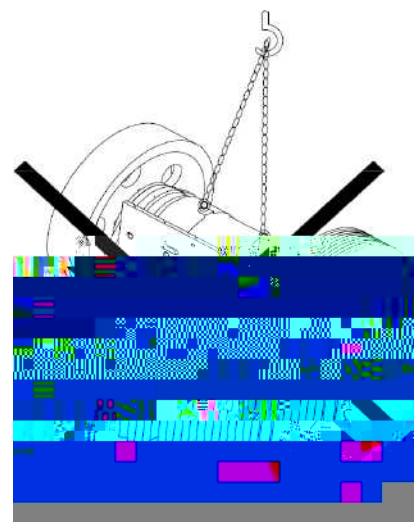
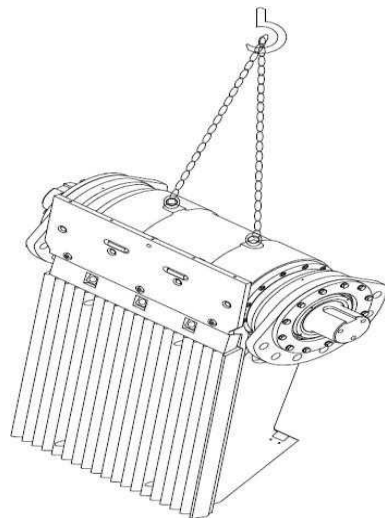
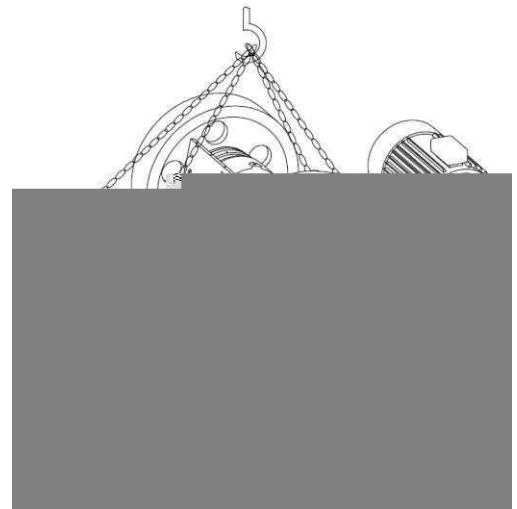
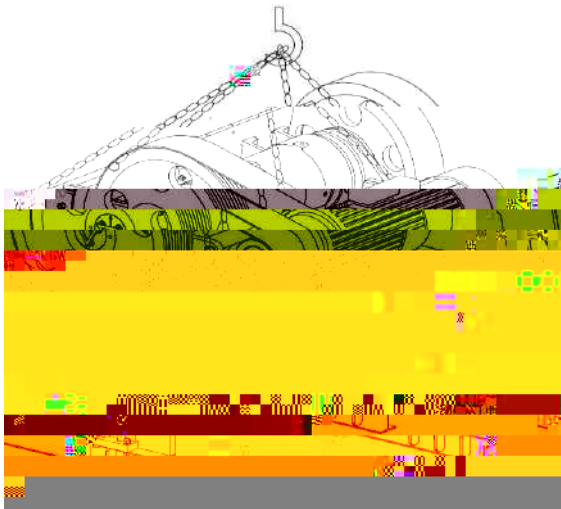

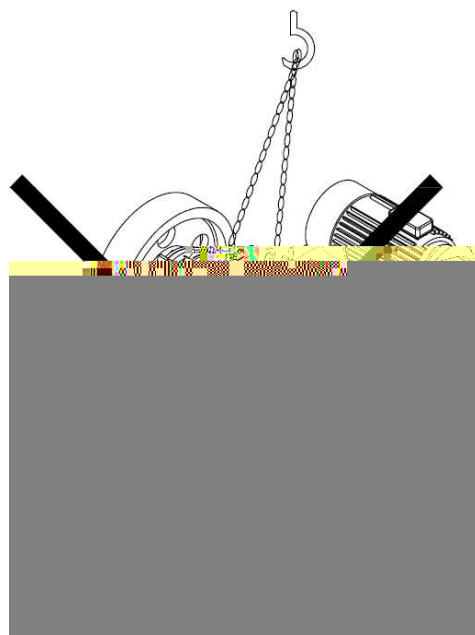

(L)530mm

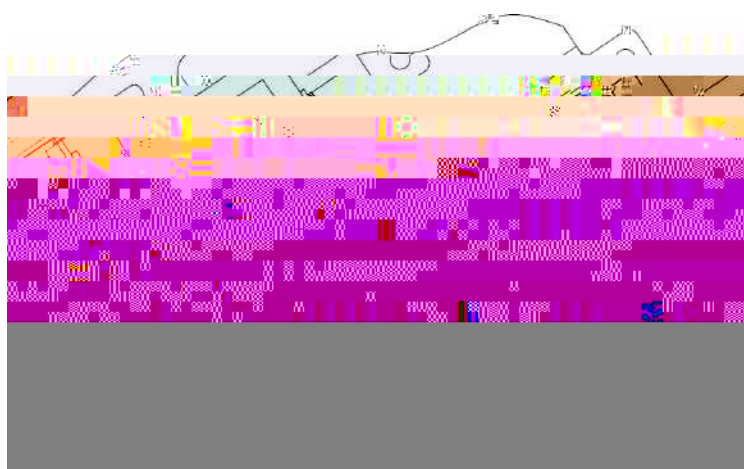

M76

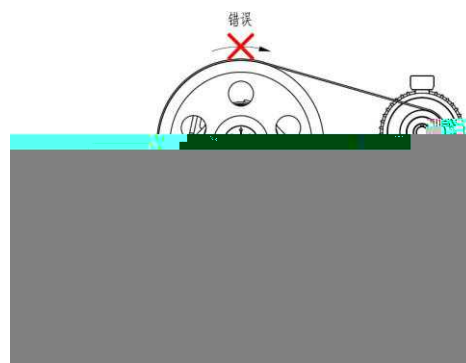
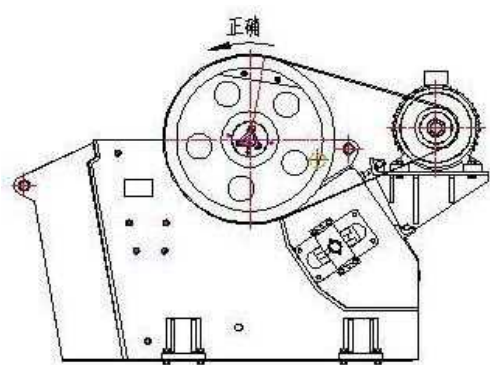

4.2.2

2h

75 ,

35

4.2.3

8h

35

4.2.4

1

160

6.

5.3

5.

2

5.1

" "

" " " "

5.1.1

"

"

5.1.2



"

/

"

"

"

"

" "

5.1.3

" "



" "

5.2

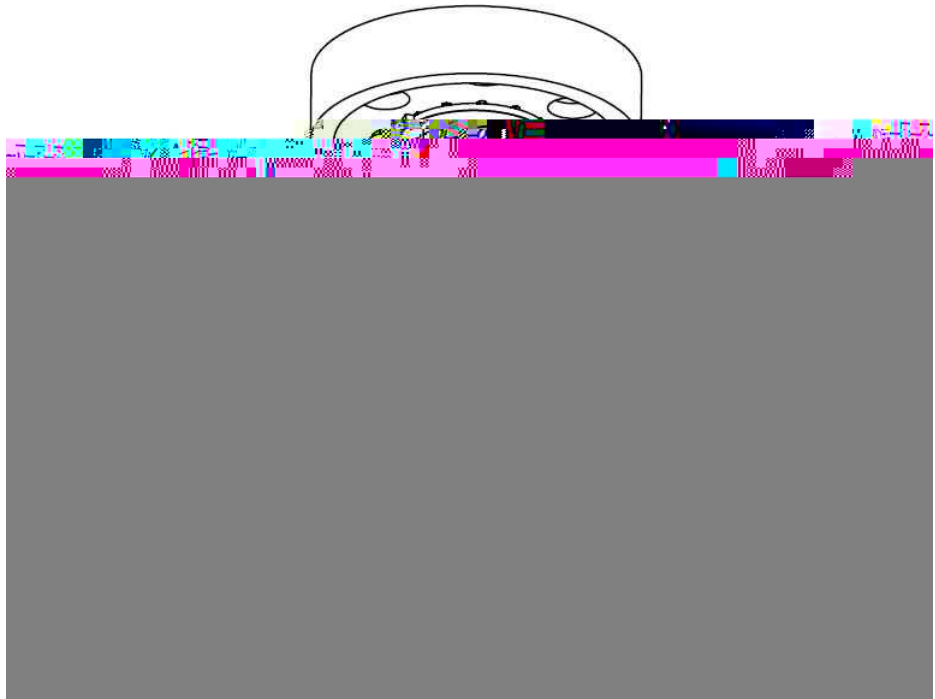

" "

" "

5.3



“ ”

		70 °C	–
			–
			5.5
40			6.2
			6.2
			6.2
			–
80			5.6
			6.2

5.4

CSS		
		/
46 mm		/
46 mm		/
30 mm		
36 mm		
24 mm		
2		
		-
		-
		-
		-

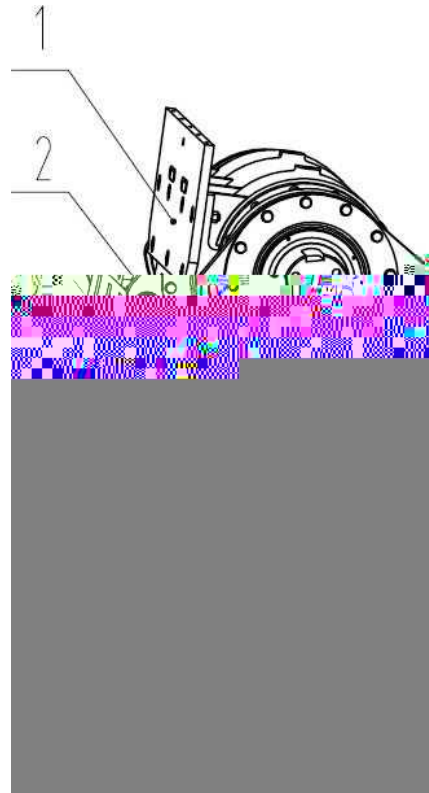
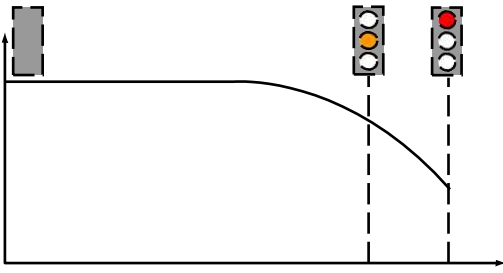

- 1
- 2
- 3

5.5.2

1

1

5.5.3

2

3

2

5.5.4

2

1

1
2

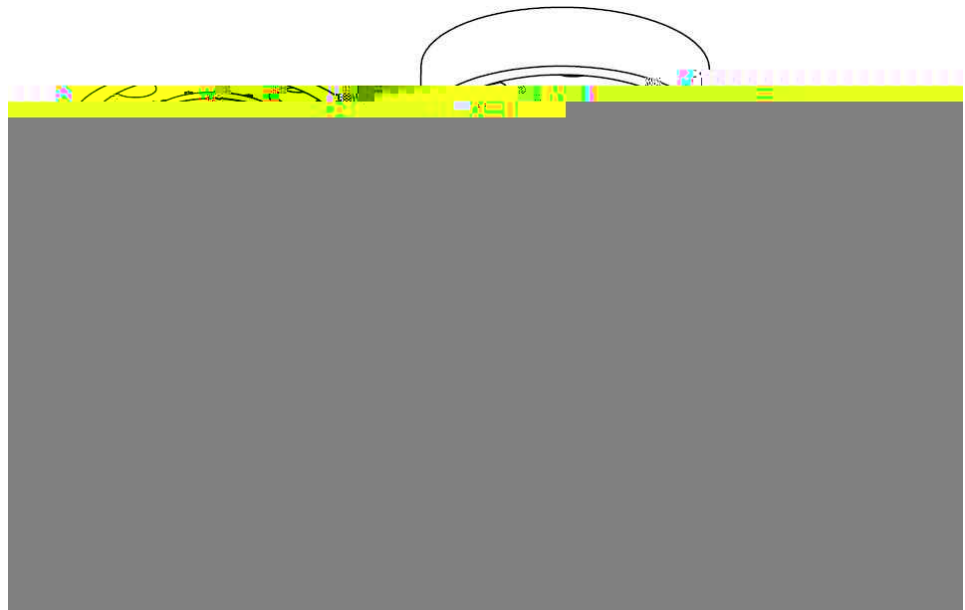

5.6



“ ”

2 5

4

5.6.2

4

2

5

1
2
3
4
5

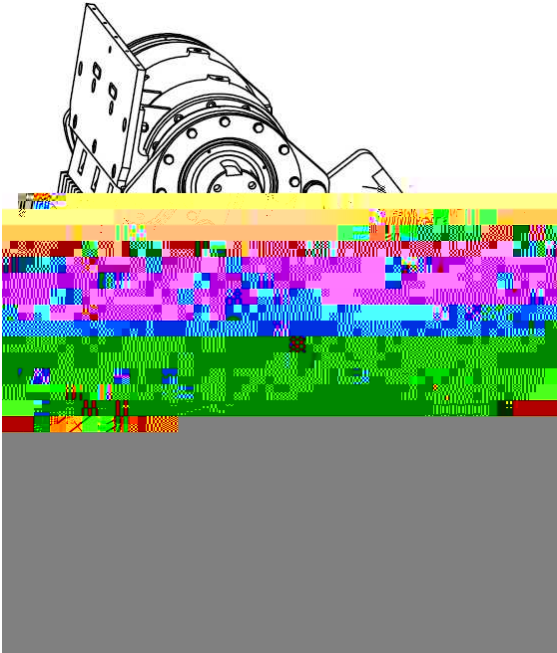

5.7



5.7.1

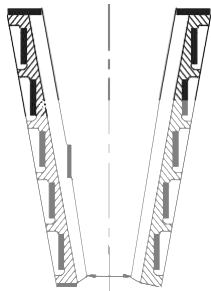

CSS

CSS

CSS

CSS

CSS

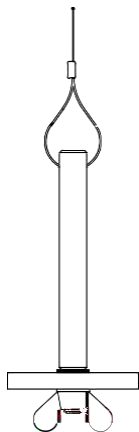

Phoenix

PV-Jaw C

6.1

"

6.2



6.2.2



6.2.1



0°C

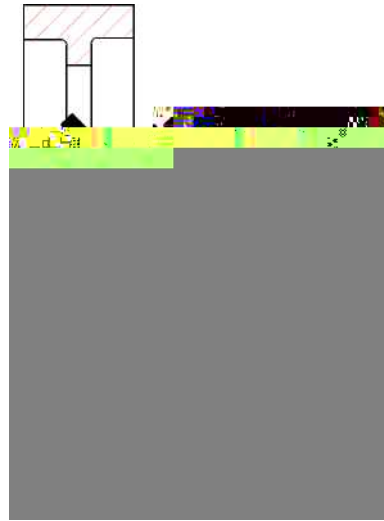

2

1
2

1

2

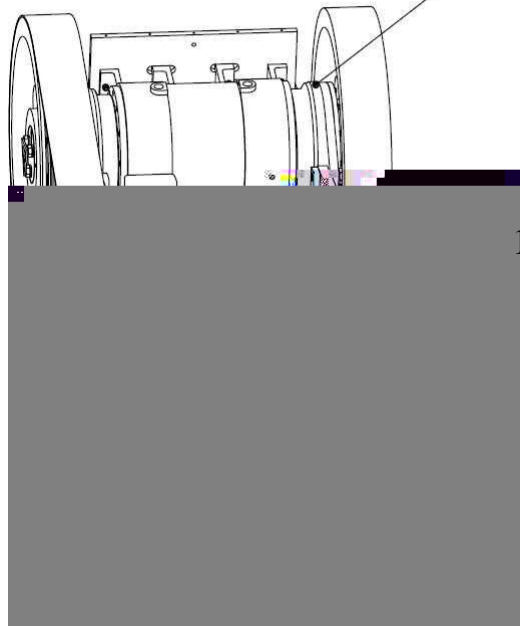

1

7.

2.

Phoenix

PV-Jaw Crusher

7.2



28



2



7.3

	1	116 kg
M56×615	3	
M56	6	
56	3	
	1	145 kg
M56×1155	3	
M56	3	

!

15%

6mm† 8mm

7.3.1

a)

7.4

7.6

b)

2

4

c)

4

d)

46 mm
46 mm

- 1
- 2
- 3
- 4

7.3.2

a)

b)

3

2

c)

4

3

d)

4

10 mm

e)

5.3

7.4

	1	2690 kg
	1	1691 kg

!

15%

6mm† 8mm

2.

e)

f)



g)



2.

h)

2



i)

2

1

2



7.4.2

1

a)

b)

2

1

2



()



2.

c) 2

d) 2

e) 2

f) 2 1

g)

h) 1 2

i) 1

j)

k)

732

7.5

	1	276 kg
M20x100	4	
20	4	
M20	4	

c)



2.

- d) (1) (2) (3)
- e) 1 6
- f) 1
- g) 1
- h) 1

7.5.2

- 1
- 2
- 3
- 4
- 5
- 6

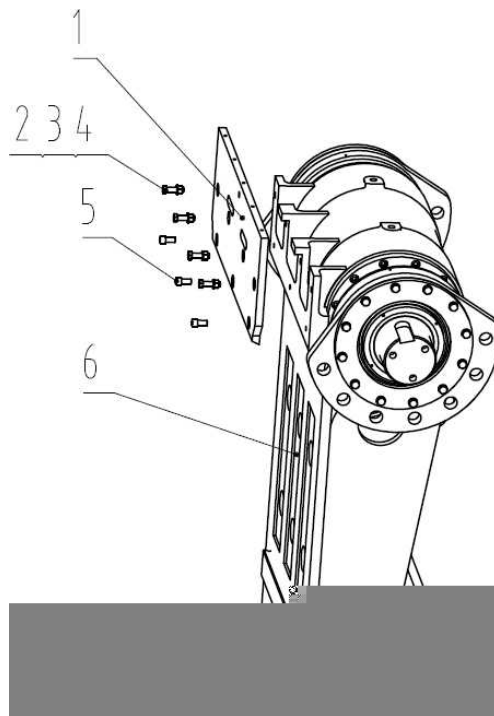

-
- a) 6 1
- b) 1
- c) 1 1
- d)



2.

- e) 1
- f) (1)
- g) (5) (2) (3) (4)
- (1)
- h)
- i) 1

7.6

	1	248kg
	1	154kg
	1	248kg
	1	154kg
M36×130	12	
M36×120	2	

7.6.1

1 7 2 5
3 4

36 mm

- a) 4 3
- b) 2
- c) 2
- d) 1

- 1
- 2
- 3
- 4
- 5

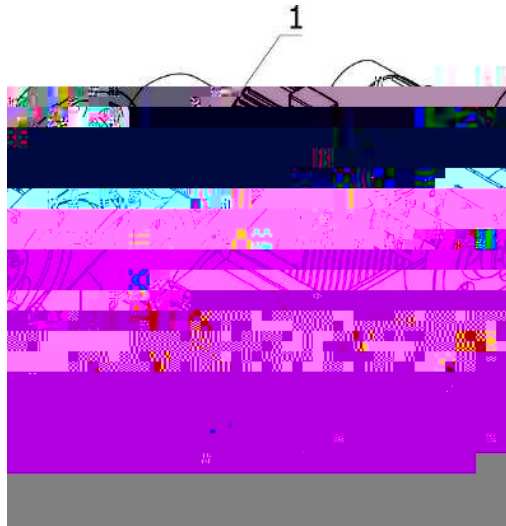

- e) 1



DIN8555E8-200ckZ

2.7

f)



2.

g)

4

3

2

5

h)

i)

7.6.2

a)

5

b)

c)

d)



2.

e)

f)

2

g)

2

3

4

h)

i)

j)

4

- 1
- 2
- 3
- 4
- 5



8.

2.

8.1

" "

" " " "

8.2

CSS



5.

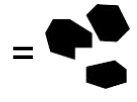
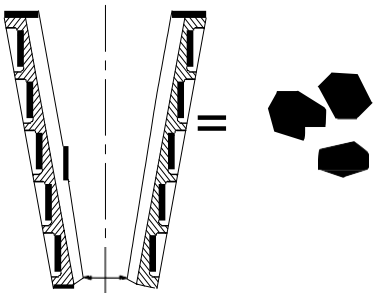
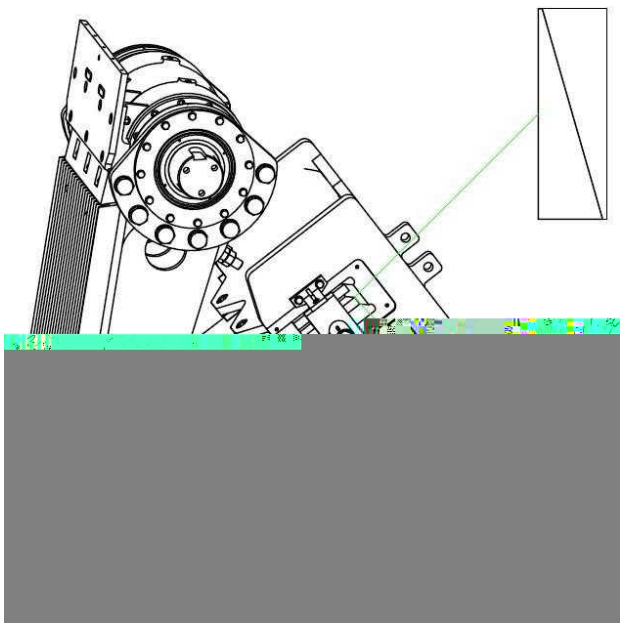
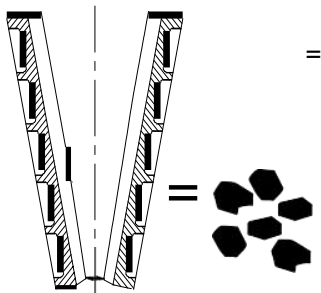

8.3

4 5 2
(3) (6)
1

- 1
- 2
- 3

8.3.1

CSS

CSS

5.7

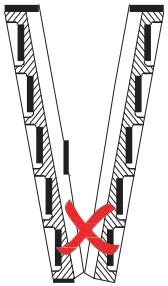

9.

2.

9.1

" "

" " " "

9.1.1

"

"

9.1.2.



"

/

"

"

"

"

" "

9.1.3.



"

"

" "

9.2

1			
		V	
			2.9
2		V	
			*
			2.9
		V	*
			8.
3		V	
4			5.
			5.
			8.
			5.
5			
6			
7			75 °C

8			5.
			5.
9			5.
10			2.9
			8. 5.6
11			8.
			5.7
			5.
			8.
			5.7
12			8.
		" "	5.

